

STRATEGIC PLANNING FOR WATER RESOURCES, DEVELOPMENT AND IMPLEMENTATION OF NOVEL BIOTECHNICAL TREATMENT SOLUTIONS AND GOOD PRACTICES (SPRING)



Coordinator (EU)

Prof. Rajnish Kaur Calay

University of Tromsø, Norway

Timeline: August 2019 - July 2024

Coordinator (India)

Prof. Sanjukta Patra

Indian Institute of Technology Guwahati, Assam

Timeline: May 14, 2020 - May 13, 2024

Review Meeting: January 30, 2024

1. DEVELOPMENT OF METHODOLOGY FOR WATER QUALITY HOTSPOT IDENTIFICATION - I

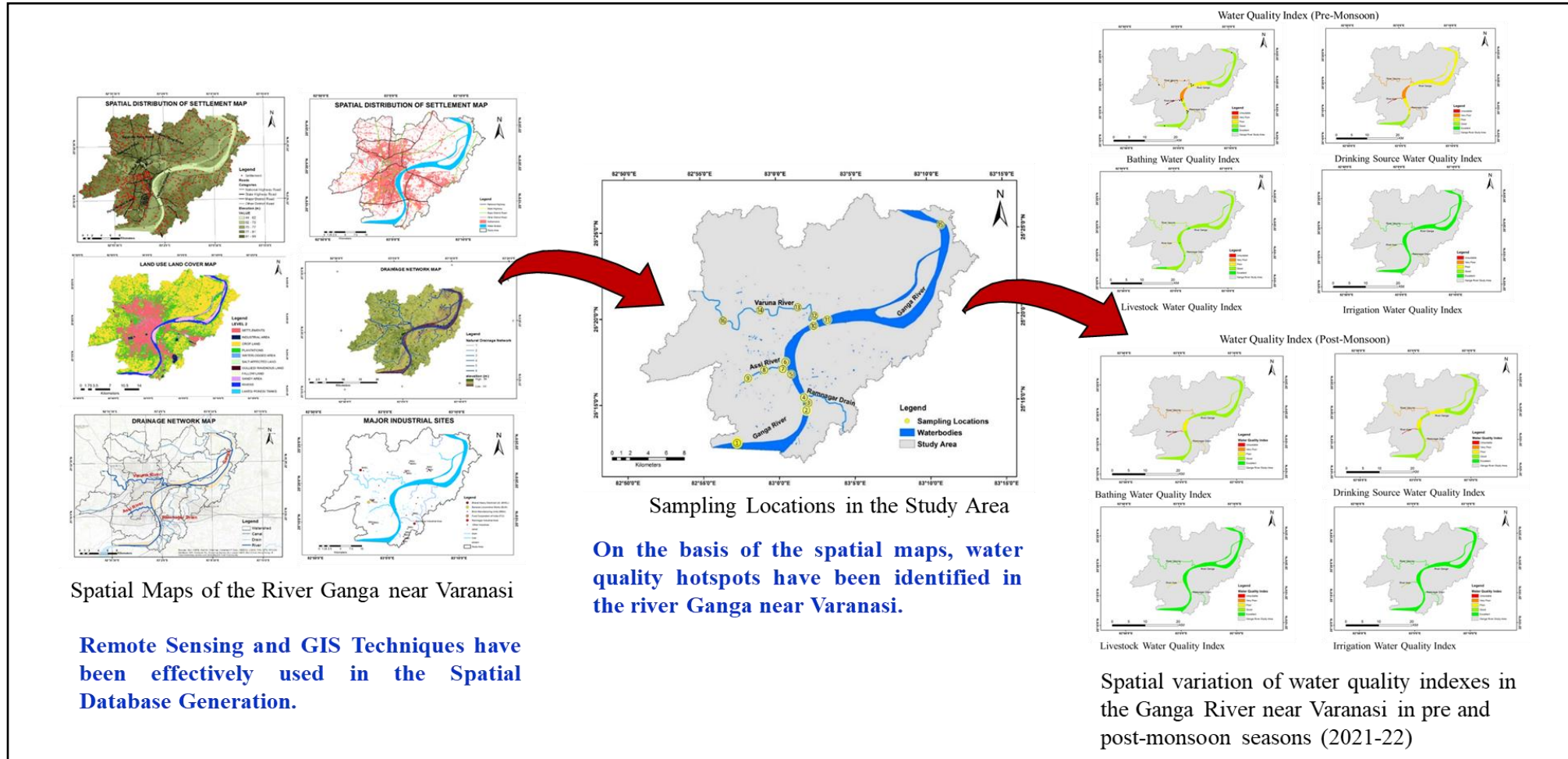

- Identification of water quality hotspots in river system is a challenge because of extensive sample collection and laboratory analysis.
- A **methodology has been developed to identify water quality hotspots** using GIS and remote sensing techniques. Additionally, Spatial distribution of Water Quality Indexes (WQI) for different purposes and **River Health Index (RHI)** has been developed.
- Government departments and agencies such as Ministry of Jal Shakti (MoJS), National Mission for Clean Ganga (NMCG), Ministry of Agriculture, Department of Drinking Water, etc. using river water as source can be the beneficiary from such innovative approaches.
- The economic benefits of **improved river water quality and better river health** can be estimated using the framework.

2. DEVELOPMENT OF METHODOLOGY FOR WATER QUALITY HOTSPOT IDENTIFICATION - II

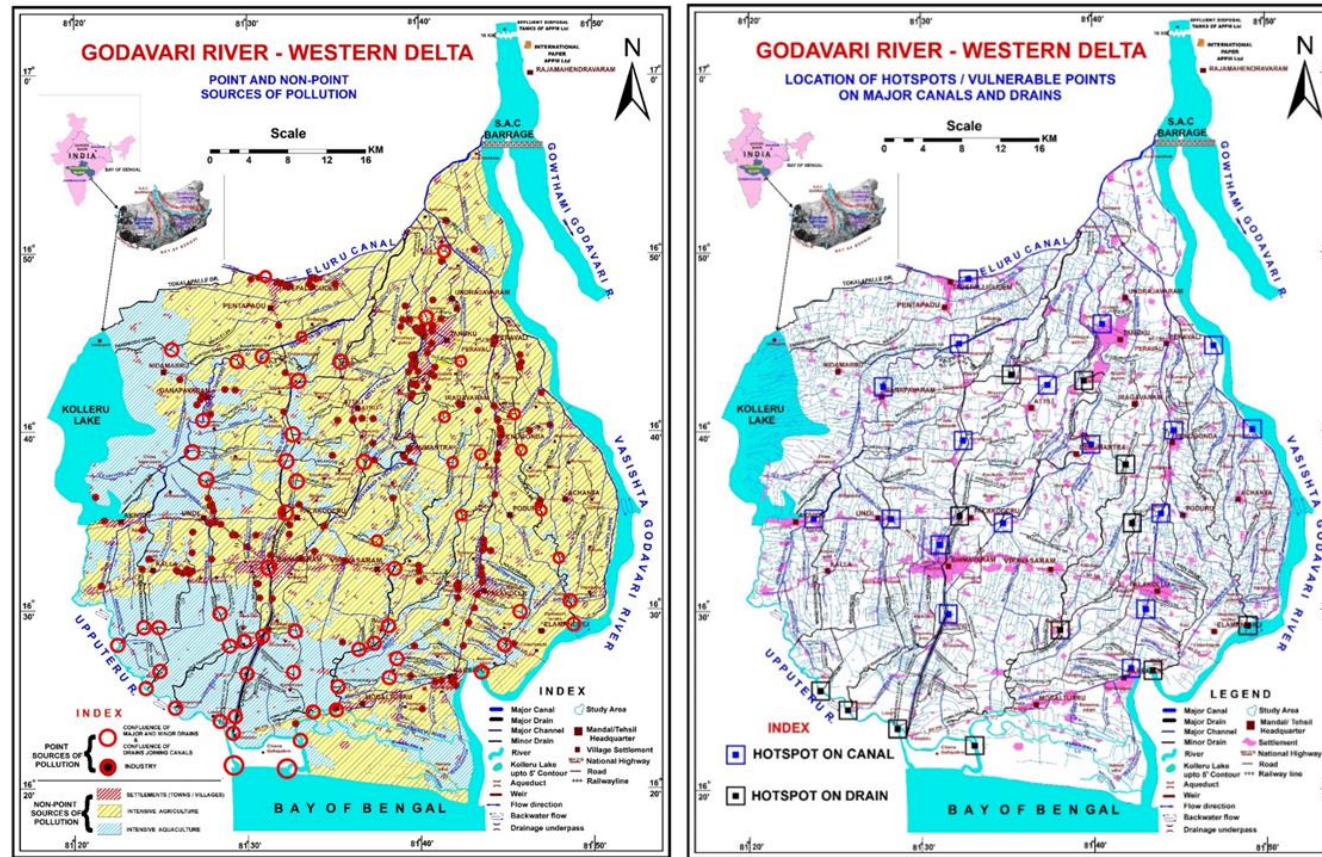

The maps provide crucial inputs:

- Related to **pollutant types** and their **respective levels of severity** in the study area.
- Identify the **settlement areas** that are particularly vulnerable to these pollutants, indicating potential risks to residents.
- Helps in understanding the **distribution and intensity of pollutants** aids in optimizing water purification processes.
- Additionally, it helps in **assessing the suitability of sensors to monitor and manage pollution** in these environments.
- Government departments and agencies using river water as source can be the beneficiary from such innovative approaches.

3. XANTHINE OXIDASE

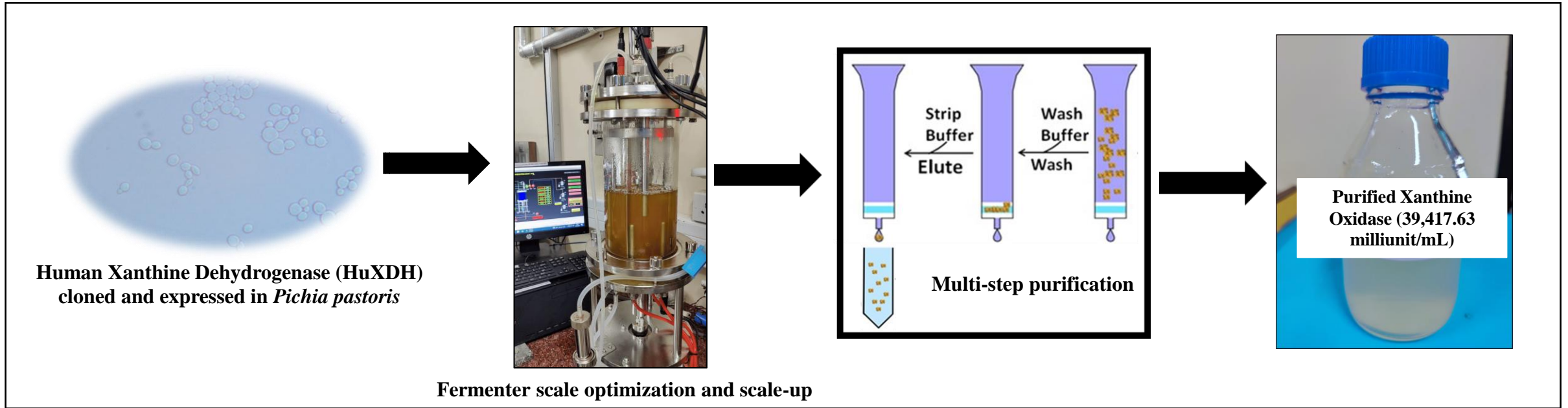

WHAT IS THE NEED?

- Sustainable enzymes as green sustainable products.
- Technological innovations and wide industrial scope.
- The major end-users: Industries and Academia.

CHALLENGES

- Quality
- Safety
- Consumer perception towards enzymes

GLOBAL ENZYME MARKET

- Expected a CAGR of approximately 6.8% (2022-2027).
- Expected to reach USD 16.9 billion by 2027.

COMPETITION

- Key players include Sigma-Aldrich, Merck Millipore, HiMedia Laboratories, Scientific Laboratory Supplies Ltd., Creative Enzymes, etc.

4. DEVELOPMENT OF MULTIPARAMETRIC REAL-TIME WATER MONITORING SYSTEM TO ACCESS POLLUTION HETEROGENEITY

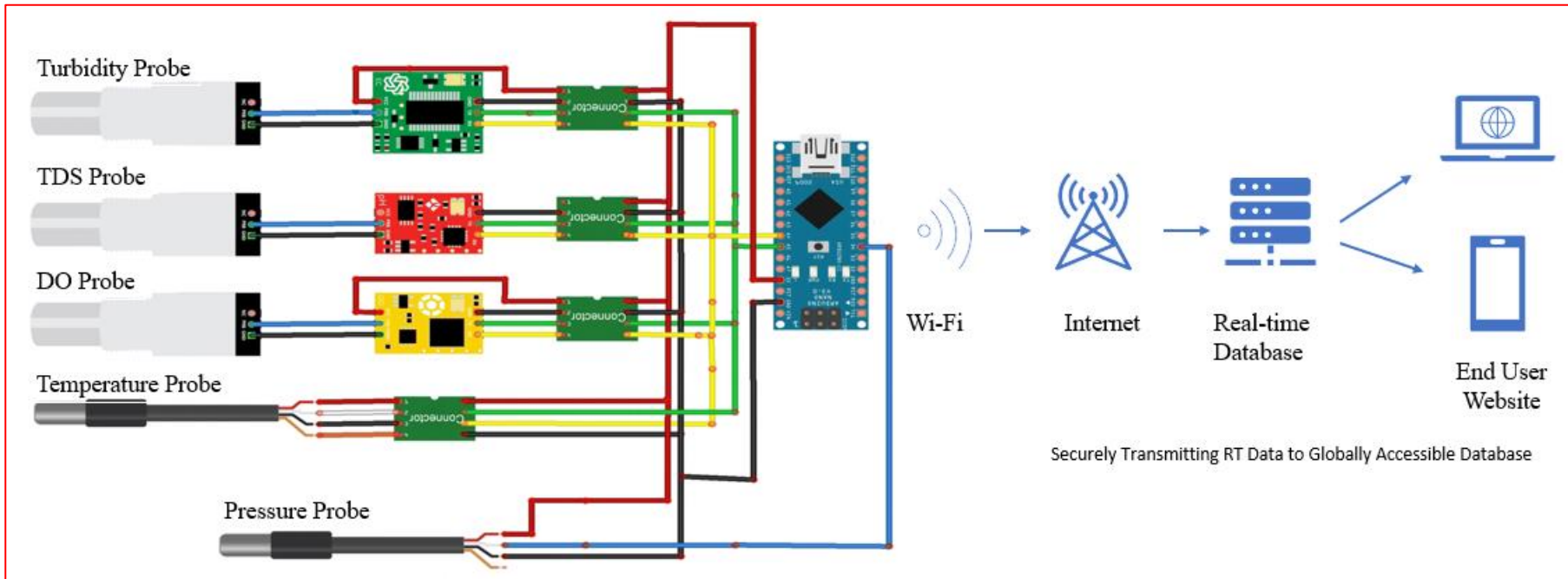

End –User Experience



Developed Prototype

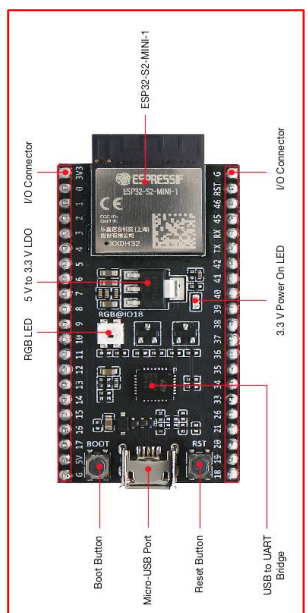

Robust Design | Ultra-Low Power Consumption | High Level of Integration | Hybrid Wi-Fi & Bluetooth Chip

- Capable of functioning reliably in industrial environments, with an operating temperature ranging from -40°C to $+125^{\circ}\text{C}$.
- Engineered for mobile devices, wearable electronics and IoT applications, have ultra-low power consumption (3-5V).
- Highly-integrated with in-built antenna switches, RF balun, power amplifier, low-noise receive amplifier, filters, and power management modules.

Can perform as a complete standalone system or as a slave device to a host multipoint control unit, reducing communication stack overhead on the main application processor. ESP32 can interface with other systems to provide Wi-Fi and Bluetooth functionality

(A) External case of the sensor being printed with PLA filament

(B) 3D render of the case in thinker CAD

(C) Generic TDS sensor

(D) Generic turbidity sensor

(E) BME280 sensor for temperature, humidity and pressure

(F) 5V Battery

(G) Charge control unit

(H) 5V Solar Panel

Award & Support

- Supported by SPRING.
- Got RnD support from Makerbhawan foundation & Win foundation.
- Won “Best product design” at Vishwakarma awards 2023 IIT Delhi.

Use Case:

- Industrial WWTP & wastewater ejection site



- Municipal Water Points



- River Dynamics Monitoring



- Overhead Tanks



What is Unique?

- Price

Brand	Model	Price	Integrated IoT
YSI	ProDSS	₹1,57,000 - ₹2,63,000	No
Hanna	HI98194	₹1,25,000	No
WTW	Multi 3510 IDS	₹97,000	No
Our device	R-SAM-Pro	₹12,000	Yes

- Green & Sustainable Fabrication



- Artificial Intelligence & Machine Learning Ready

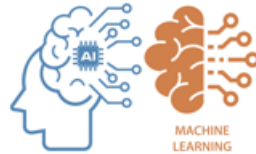

- Small Form Factor & Low Maintenance



Market Size & Growth

Demographics & End User

- The major end-user are Municipal corporations, Industries and Academia.
- The largest market is North America, followed by Asia-Pacific and Europe.

Market

- Global water and wastewater sensors market- USD 3.80 billion (2019).
- Expected to register a CAGR of approximately 7.4% (2021-2026).
- Expected to reach USD 7.5 billion by 2028.

Competition

- The water quality monitoring systems market is moderately competitive with some dominant players holding significant market share.
- Key players include General Electric Company, Shimadzu Corporation, Thermo Fisher Scientific Inc.

Market Segmentation

- Wastewater sensors market is segmented by type, application and geography.
- The major types of sensors are pH sensors, DO sensors, Temperature sensors and Turbidity sensors.

SUMMARY

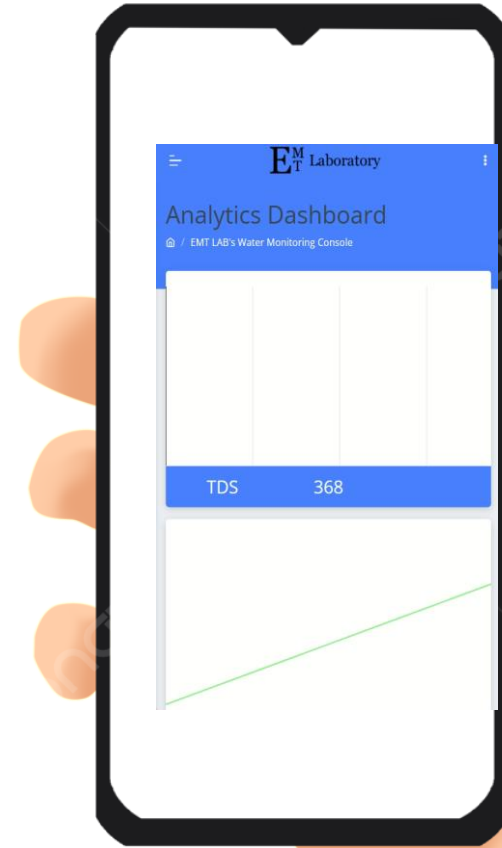
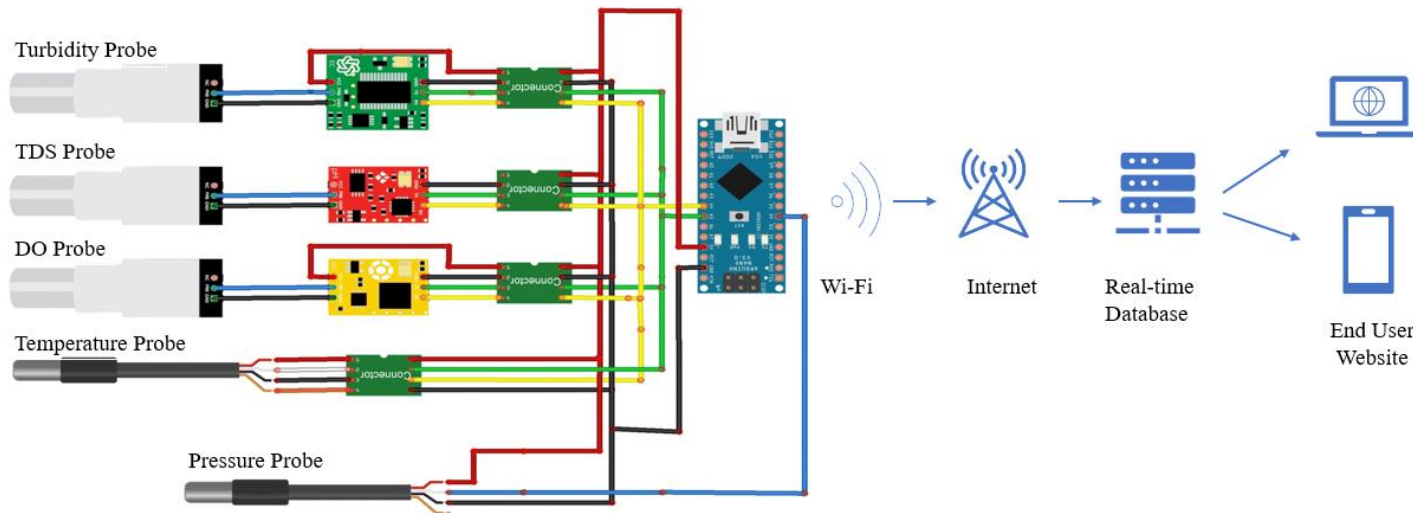
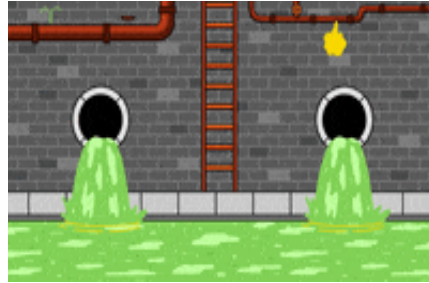

5. REAL-TIME MONITORING AND CONTROL SYSTEMS

A. Developed a multipurpose boat system:

1. Integrated modular sensoric platform
2. Capable of carrying remediation system (bio-oxidation system)
3. Robotic and Navigation system
4. Teleoperation and Autonomous operation

B. ASV Prototype - Specifications

- Dimensions of Hull: 3.6x1.4x0.7 m
 - Frame: 2.4x0.5x0.5
- Weight: 200 Kg
- Additional Payload:
 - 100Kg
 - 2m x 0.75m
- Actuation: 2-Degree of Freedom
- Autonomy:
 - Continuous Operation: 2h30m
- Speed:
 - Typical: 1.5 m/s
 - Max: 2 m/s

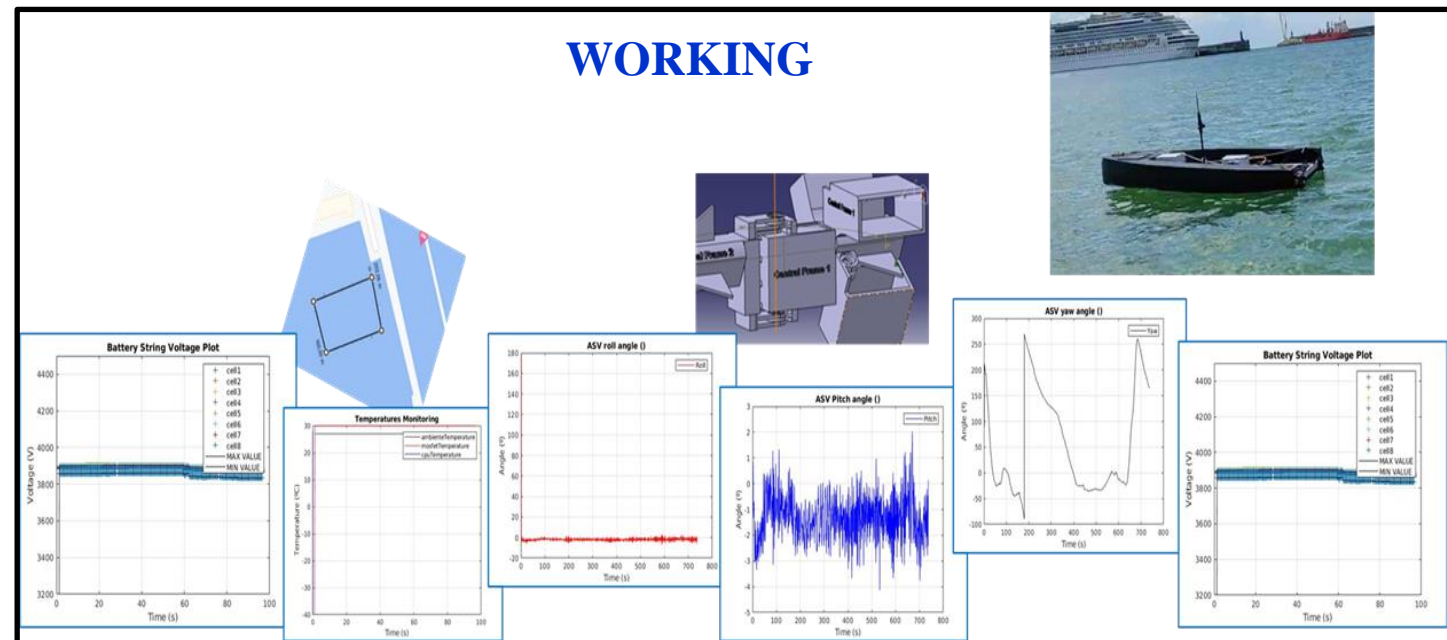
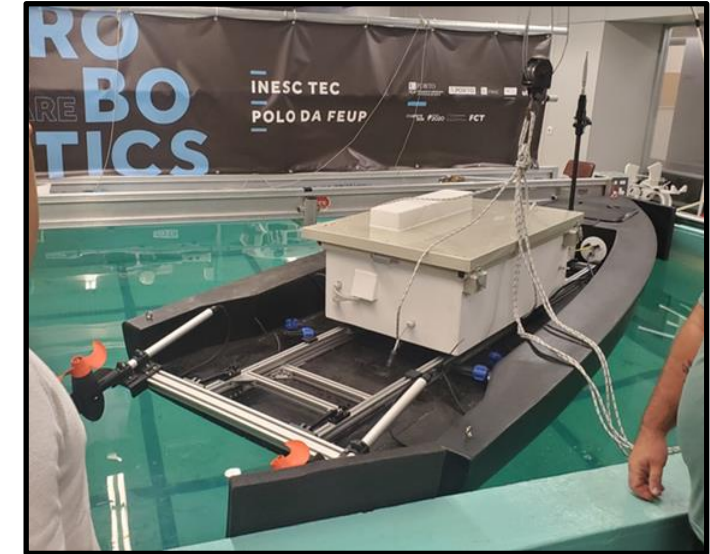
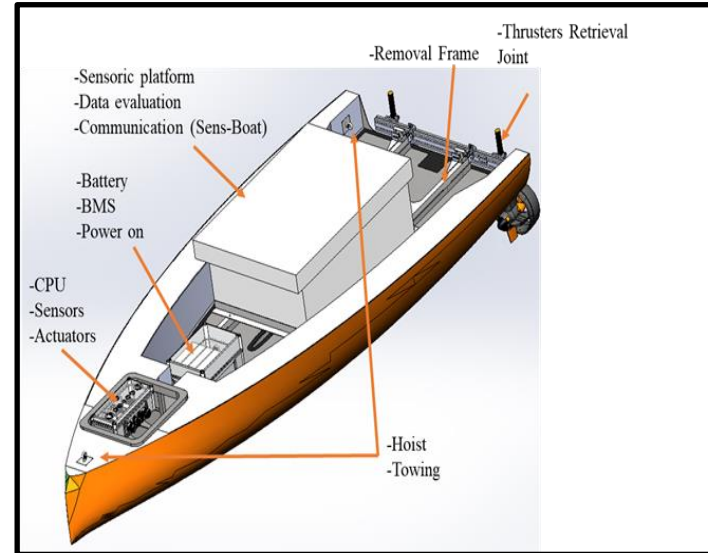

6. SEWER ROBOTIC SYSTEM FOR DETECTING UNDERGROUND WATER BLOCKAGES

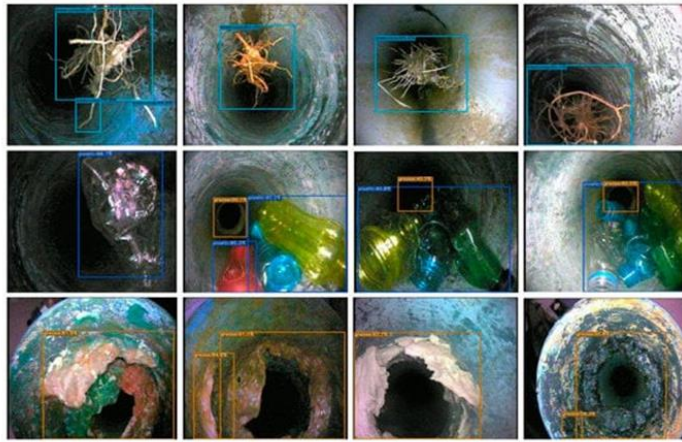

Visual upshots of detected tree roots, plastic and grease types of sewer blocks

NEWLY CREATED S-BIRD (SEWER BLOCKAGES IMAGERY RECOGNITION DATASET) Created Data -

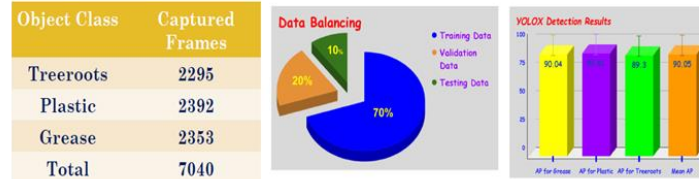
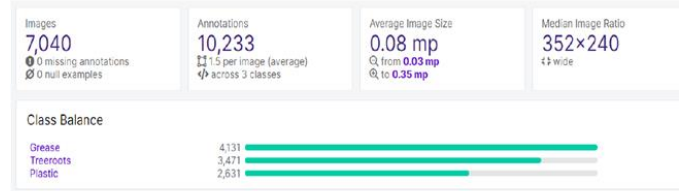

**WORKING
VIDEO
AVAILABLE**

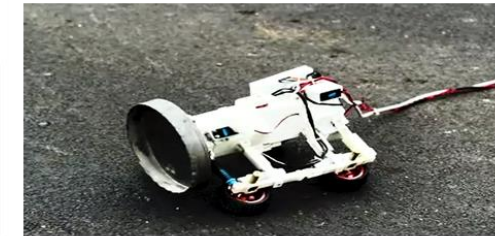

Objectives

- Development of autonomous robot to detect underground water blockages
- Algorithm development and testing
- Payload integration
- Deliver bio-oxidation system inside the pipelines to the point of blockage
- Test and validation in a realistic environment

Main Challenges and Requirements

- Data set creation, processing and training of sewer blockage images
- Selection of suitable sensors, hardware, and computational equipment
- To provide intended imagery intelligent algorithm to identify mostly occurring sewer pipeline blockages
- To develop the compact design of a sewer robotic system to intervene, identify, and remove sewer pipeline blockages with higher accuracy and efficiency
- To deploy and test the developed system in a real-time scenario

Outcome

The robotic system is capable of

- Dataset Creation, processing, and training of 10,720 images
- Navigate inside buried sewers for detecting distinct blockages by using camera-sensor and embedded vision
- Ability to deploy the enzymes at point of contact
- The AI detection algorithm with newly created imagery dataset is the main facet in the development
- It solve human scavenging issue by removing sewer blockages in real time

7. MICROBIAL SENSORY PLATFORM FOR BOD AND TOXIC COMPOUND DETECTION

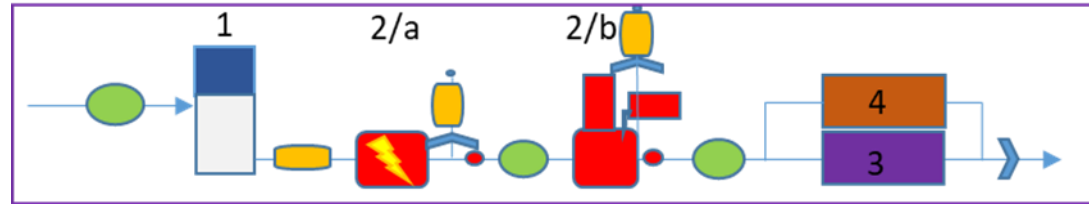

1. Sensoric unit measuring basic parameters



This unit is able to measure: Temperature, pH, Turbidity, Salinity, Conductivity, DO (Dissolved oxygen) ORP (Oxidative Reductive Potential), Ammonium- and Chloride concentration, and Pathogenic bacterium number - coliforms

2. Water sample pre-treatment units



Vacuum combined sonication and disinfection unit pretreats water samples for the MFC units



3. MFC sensoric units

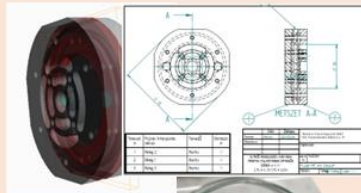

Small scale MFCs were established and integrated into the sensoric platform

4. Heavy-metal sensoric unit

NIR was planned, but now printed sensoric units are under construction. Cu, Hg, Ar



Printed sensors are under field tests

5. Data acquisition and control

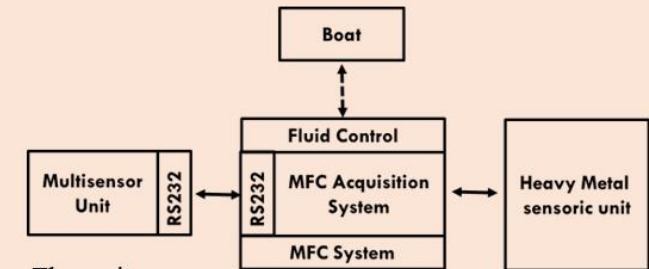

The unit:

- collects data, from the sensoric systems,
- controls sampling and sample treatments,
- has the ability to perform samplings and tests in the determined/installed time periods,
- communicates with the central computer of the sampling boat during that receives commands and modifies sampling times.

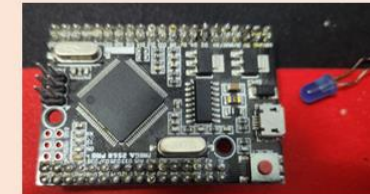

FACTS

- Need for cheap on-site environmental sensors to measure BOD (biological oxygen demand) and toxicity.
- Microbial Fuel Cell based sensors can be ideal as they have the capacities to measure the presence of organic material and theoretically the gained signal is proportional to the organic input.
- The system has to be stabilised before the market can uptake it.

CHALLENGES

For proper function, the anodic part of the MFC has to be kept anaerobic!

The applied electrogenic bacterium consortium on the surface of the anode has to be protected from invasive environment and in most cases from non-electroactive bacteria!

PROGRESSION DURING SPRING

An efficient degassing method worked out, with that solubilized oxygen content of watersample could be minimised, and by that anaerobic conditions could be assured.

An effective physical disinfection method was applied before the watersample to be analysed reached the MFC units.

FURTHER CHALLENGES THAT CURRENTLY HINDER THE MARKET ROLL-OUT OF THE TECHNOLOGY

- Stabilise internal resistance through the control of biofilm formation as overgrown biofilm can spoil electronflow and by that increases internal resistance after a time, depending on the culture.
- Increase the material quality of the anode in order to facilitate electron uptake from bacteria.
- Due to slow reaction time and latency, the system is not ideal for the detection of suddenly appearing pollutants (except toxic chemicals), but rather for those purposes where monitor of long range and mild changes is sufficient (daily monitoring).

1. Pollutant heterogeneity Map of Ganga and Godavari delta

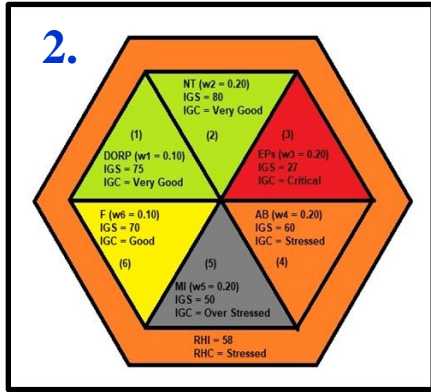

5. Purified XO

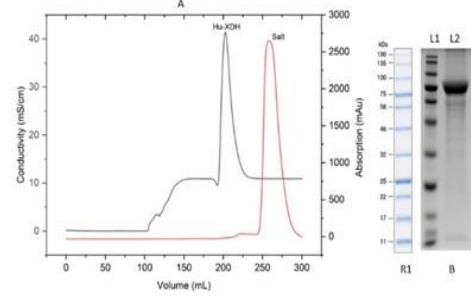

8. Microbial Fuel Cell sensor

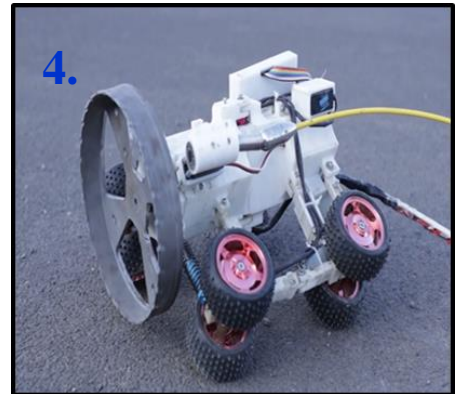
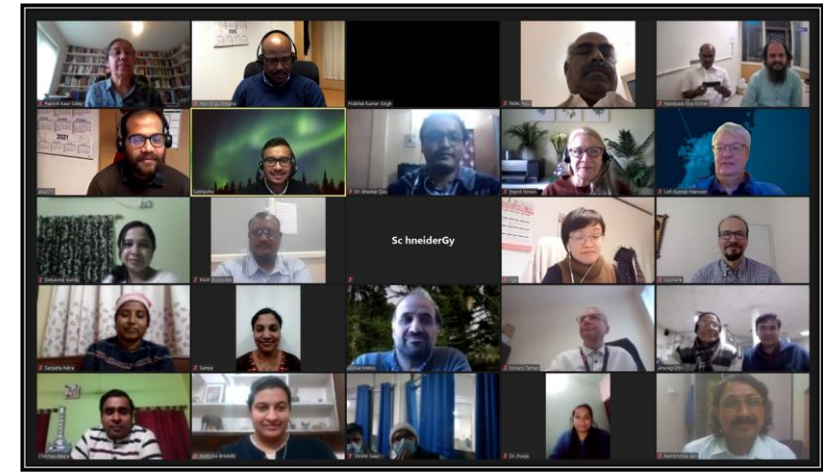

Immobilized Enzyme Bioreactor



Thank You



Horizon 2020
European Union funding
for Research & Innovation

